

ORSADRINKS

• SINCE 1992 •

ITALIAN BEVERAGE SUPPLY COMPANY

2024

ITALIANO

ODK
ORSADRINKS.COM

DROPS OF MAGIC

STILLABUNT

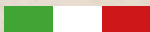



Una storia di dedizione e successo, 100% italiana

Orsadrinks nasce nel **1992** in Italia, nel sud del **Piemonte**.

Inizialmente, la gamma di prodotti si limitava a preparati in polvere come cioccolate calde e frappè ma, dopo aver osservato il boom del **mercato dei cocktail** negli USA, l'azienda decide di dedicarsi anche a questo settore.

Realtà in costante evoluzione, ha saputo cogliere, e talvolta anche anticipare, le tendenze di mercato, affermandosi come **brand di riferimento** tra i migliori bartender di tutto il mondo.

Alla **iconica linea** di prodotti **ODK**, l'azienda ha recentemente affiancato anche il brand **Stillabunt**, in un'ottica non solo di completamento di gamma, ma anche di sviluppo di **prodotti innovativi**.



ODK
ORSADRINKS.COM

DROPS OF MAGIC
STILLABUNT



La prima gamma di puree di frutta, la linea dei Fruity Mix, viene lanciata in Italia nel 1994.

Il primo decennio degli anni 2000 è stato caratterizzato dalla **dedizione** alla **ricerca** e allo **sviluppo**: partendo da una gamma limitata di prodotti, l'azienda ha ampliato la propria offerta con nuovi gusti e prodotti.



L'attività di **Export** inizia nel **2009**.

Nel secondo decennio degli anni 2000 l'azienda ha subito una **ristrutturazione**, sia a livello aziendale che nella struttura organizzativa, al fine di poter supportare uno sviluppo su scala globale.



**L'AUTENTICITÀ DELLA
FILOSOFIA MADE IN ITALY,
DAL PIEMONTE ALLA
CONQUISTA DEL MONDO**

In questa fase l'azienda ha deciso di **internalizzare** la **produzione** investendo ingenti somme in macchinari tecnologici altamente automatizzati.

Oggi, Orsadrinks è un partner fidato ed un marchio di riferimento nel settore delle bevande in **più di 50 Paesi in tutto il mondo**, con una gamma di **oltre 150 prodotti**.



**IMPIANTI DI PRODUZIONE
ALL'AVANGUARDIA
ED UN'AVANZATA
TECNOLOGIA DI PROCESSO**

Il **nostro** team è il cuore pulsante dell'azienda: da sempre, siamo fieri delle diverse origini, vocazioni e caratteristiche di ciascun membro della famiglia Orsadrinks. La nostra organizzazione è infatti costituita da persone provenienti da background molto differenti e crediamo fermamente che questa varietà innata dei nostri partner, dislocati in tutto il mondo, arricchisca costantemente la nostra azienda.



**UNA RETE GLOBALE
DI SINERGIE PREZIOSE,
PER SUPPORTARE I NOSTRI
CLIENTI IN TUTTO IL MONDO**

Gusto, qualità e naturalità: i valori fondamentali della nostra filosofia aziendale

L'autenticità della filosofia **"Made in Italy"** è alla base della produzione di Orsadrinks, che si contraddistingue per la grande attenzione alla **qualità** e alla **naturalità**.

La mission aziendale è di creare prodotti dal gusto eccellente e pratici da utilizzare, impiegando solo ingredienti di altissima qualità.

L'impegno di Orsadrinks a migliorare la propria offerta attraverso la **ricerca** e la **continua innovazione tecnologica** consente di arricchire costantemente la gamma di prodotti, al fine di soddisfare e superare le aspettative dei barman di tutto il mondo, fornendo soluzioni per ogni occasione, dal mattino fino a tarda notte.

Siamo situati nel cuore del **Piemonte**, regione in cui si trovano alcune delle più importanti eccellenze naturalistiche del mondo, ed in particolar modo molto vicino alla regione delle **Langhe**, riconosciute come Patrimonio Unesco. La nostra azienda si trova ai piedi delle **Alpi**, di fronte a una delle montagne più famose d'Italia: il Monviso, sulle cui pendici settentrionali ha origine il fiume più lungo d'Italia, il Po. Grazie a questa posizione privilegiata, possiamo approvvigionarci di **acqua**, l'ingrediente principale di tutti i nostri prodotti, proveniente direttamente dalle Alpi.



ODK
DESIGNING & CO.

GREEN APPLE
MELA VERDE
LMF010PSA



KIWI
LMF008PSA



PAPAYA
PAPAIA
LMF012PSA



PEAR
PERA
LMF007PSA



BANANA
LMF002PSA



YUZU
LMF024PSA



PEACH
PESCA
LMF013PSA



MANGO
LMF021PSA



PINK GRAPEFRUIT
POMPELMO ROSA
LMF022PSA



MANDARIN
MANDARINO
LMF014PSA

ODK
DESIGNING & CO.

MELON
MELONE
LMF011PSA



PASSION FRUIT
MARACUJA
LMF009PSA



BLOOD ORANGE
LMF028PSA



APRICOT
ALBICOCCA
LMF026PSA



PINEAPPLE
ANANAS
LMF003PSA



COCONUT
COCO
LMF004PSA



CHERRY
CILIEGIA
LMF018PSA



STRAWBERRY
FRAGOLA
LMF001PSA



CRANBERRY
LMF005PSA



WATERMELON
ANGURIA
LMF020PSA



LYCHEE
LMF019PSA



POMEGRANATE
MELOGRANO
LMF006PSA



RASPBERRY
LAMPONE
LMF015PSA



WILD BERRY
FRUTTI DI BOSCO
LMF017PSA

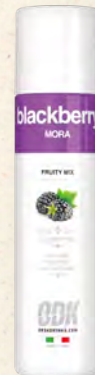

BLACKBERRY
MORA
LMF016PSA



BLUEBERRY
MIRTILLO
LMF025PSA



Fruit Puree

Puree di frutta fresca di prima qualità,
per un'esplosione di gusto

Pouches 600 ml 6 Pouches/scatola

La linea ODK **Fruit Puree** è una gamma di puree realizzate con il **100% di frutta**.

Un'ampia scelta di gusti, che contengono frutta attentamente selezionata e **soli zuccheri** della **frutta**, per ottenere un prodotto di altissima qualità ed un **gusto fresco ed autentico**.

Le puree di frutta ODK sono perfette per la **preparazione di cocktail, frullati, gelati, coulis e dessert**: il tocco ideale per arricchire le vostre creazioni con un'esplosione di gusto.



LIME 100%
SUCCO DI LIME
LFJ007P6A

LEMON 100%
SUCCO DI LIMONE
LFJ006P6A

YUZU 100%
SUCCO DI YUZU
LFJ012P6A

RASPBERRY
PUREA DI LAMPONE
LFP005P6A

BLACKBERRY
PUREA DI MORA
LFP010P6A

PEAR
PUREA DI PERA
LFP011P6A



MANGO
PUREA DI MANGO
LFP003P6A

STRAWBERRY
PUREA DI FRAGOLA
LFP001P6A

PASSION FRUIT
PUREA DI PASSION FRUIT
LFP004P6A

WHITE PEACH
PUREA DI PESCA BIANCA
LFP009P6A

COCONUT
PUREA DI COCCO
LFP008P6A





ODK Syrup

I migliori sciroppi
per le vostre preparazioni

Rinomata per l'**ampia offerta** di **gusti**, la linea di Sciroppi ODK si distingue per l'alta concentrazione di gusto, che si traduce in un **aroma** molto **fresco** ed **autentico**.

L'intera gamma conta oggi **più di 60 gusti** ma è in costante crescita per anticipare le tendenze del mercato e per soddisfare le esigenze dei nostri clienti in tutto il mondo.

Gli Sciroppi ODK contengono solo coloranti naturali e sono privi di sostanze OGM e di conservanti.



Bottiglie 750 ml
6 bottiglie/scatola

 BOTT. VETRO
 BOTT. PET

Gli sciroppi ODK sono molto **versatili**; inoltre, grazie al loro **gusto** molto **concentrato**, una piccola quantità di prodotto è sufficiente per aromatizzare drink sia caldi che freddi, ma anche milkshake e molto altro!





BANANA
G LSY032GSA



**COCONUT
COCCO**
G LSY004GSA
P LSY004PSA



**WHITE PEACH
PESCA BIANCA**
G LSY028GSA



**PASSION FRUIT
MÁRACUJA**
G LSY042GSA



GUAVA
G LSY022GSA



**PEACH
PESCA**
G LSY051GSA



**WILDBERRY
FRUTTI DI BOSCO**
G LSY035GSA



MANGO
G LSY046GSA



**MELON
MELONE**
G LSY070GSA
P LSY070GSA



YUZU
G LSY071GSA
P LSY071GSA



**WATERMELON
ANGURIA**
G LSY034GSA



**RASPBERRY
LAMPONE**
G LSY026GSA



**STRAWBERRY
FRAGOLA**
G LSY001GSA
P LSY001PSA



**CASSIS
RIBES NERO**
G LSY033GSA



**BLACKBERRY
MORA**
G LSY043GSA



CHAI TEA
G LSY041GSA



**TONKA BEAN
FAVA TONKA**
G LSY063GSA



**WHITE MINT
MENTA BIANCA**
G LSY005GSA



**GINGER
ZENZERO**
G LSY007GSA



**CHILI
PEPERONCINO**
G LSY016GSA



**GREEN APPLE
MELA VERDE**
G LSY024GSA



**GRENADINE
GRANATINA**
G LSY002GSA
P LSY002PSA



KIWI
G LSY061GSA



**BLUEBERRY
MIRTILLO**
G LSY060GSA



**PINEAPPLE
ANANAS**
G LSY045GSA



**CARDAMOM
CARDAMOMO**
G LSY037GSA



**PINK GRAPEFRUIT
POMPELMO ROSA**
G LSY067GSA
P LSY067PSA





MAPLE ACERO
 G LSY014GSA



TEA MATCHA
 G LSY062GSA



BASIL BASILICO
 G LSY017GSA



CUCUMBER CETRIOLO
 G LSY018GSA



RHUBARB RABARBARO
 G LSY013GSA



PIÑA COLADA
 G LSY029GSA



MOJITO
 G LSY025GSA



MARGARITA
 G LSY053GSA



ITALIAN SPRITZ
 G LSY054GSA



RHUM
 G LSY030GSA



AGAVE
 G LSW000GSA



GREEN MINT MENTA VERDE
 G LSY023GSA
 P LSY023PSA



ORGEAT ORZATA
 G LSY006GSA
 P LSY006PSA



IRISH CREAM
 G LSY027GSA



FALERNUM
 G LSY012GSA



MULLED WINE VIN BRULÉ
 G LSY055GSA



JASMINE GELSOMINO
 G LSY038GSA



POPCORN
 G LSY069GSA
 P LSY069PSA



TROPICAL BLU
 G LSY003GSA



BUBBLEGUM
 G LSY040GSA



WHITE SUGAR ZUCCHERO BIANCO
 G LSY001GSA
 P LSY001PSA



CANE SUGAR ZUCCHERO DI CANNA
 G LSY002GSA
 P LSY002PSA



ELDERFLOWER FIORI DI SAMBUCO
 G LSY015GSA
 P LSY015PSA



ROSE ROSA
 G LSY031GSA



VIOLET VIOLETTA
 G LSY011GSA



LAVENDER LAVANDA
 G LSY052GSA



HIBISCUS IBISCO
 G LSY056GSA



SALTED CARAMEL
CAPAMELLO SALATO
G LSY020GSA
P LSY059GSA



AMARETTO
G LSY020GSA
P LSY020PSA



CINNAMON
CANNELLA
G LSY010GSA
P LSY010PSA



WHITE CHOCOLATE
CIOCCOLATO BIANCO
G LSY048GSA



MACARON
G LSY036GSA



VANILLA
VANIGLIA
G LSY009GSA
P LSY009PSA



SPECULOOS
G LSY058GSA
P LSY058PSA



GINGERBREAD
PAN DI ZENZERO
G LSY057GSA
P LSY057PSA



CHOCOLATE
CIOCCOLATO
G LSY019GSA
P LSY019PSA



CHOCO COOKIE
COOKIE AL CIOCCOLATO
G LSY044GSA



HAZELNUT
NOCCIOLA
G LSY021GSA
P LSY021PSA



PEANUT BUTTER
BURRO DI ARACHIDI
G LSY039GSA



CARAMEL
CARAMELLO
G LSY008GSA
P LSY008PSA

Sugar Free Syrup



Il gusto autentico dei nostri sciroppi,
100% Sugar Free!

Bottiglie 750 ml 6 bottiglie/scatola

Gli Sciroppi ODK Sugar Free della linea Barista nascono dalla volontà di conciliare l'**autenticità del sapore** dei nostri sciroppi con l'attenzione al **benessere alimentare**, senza compromessi sul gusto! Gli sciroppi di questa linea sono realizzati con il **sucralosio**, un dolcificante vegano e senza calorie che conferisce una sensazione di dolcezza, **100% sugar free** e senza alcun retrogusto.

Ideali per la preparazione di ricette a base di **caffè, latte, tè...** ma anche per creare **cocktail e bevande dissetanti!**



VANILLA
VANIGLIA

LSYSF009GSA
LSYSF009PSA



HAZELNUT
NOCCIOLA

LSYSF021GSA
LSYSF021PSA



CARAMEL
CARAMELLO

LSYSF008GSA
LSYSF008PSA





ODK Iced Tea

Freschi, dissetanti, versatili
e pronti in pochi secondi.

Bottiglie 750 ml

6 bottiglie/scatola

Gli Iced Tea ODK sono il risultato di oltre 20 anni di Ricerca e Sviluppo: 9 gusti fra cui scegliere, **molto concentrati** e realizzati utilizzando solo **ingredienti naturali**, senza conservanti o coloranti artificiali. Dal classico Tè Freddo, ai più esotici Tè Rooibos, questa linea contiene tutta la fragranza della **frutta matura**, dell'**estratto di tè** e degli **oli essenziali**, che ne esaltano le già notevoli caratteristiche organolettiche. Gli Iced Tea ODK rappresentano la soluzione ideale per realizzare bevande rinfrescanti e per aromatizzare in maniera originale le vostre creazioni!



ROOIBOS
RED TEA
P LTE007PSA



ROOIBOS
VANILLA
P LTE008PSA



ROOIBOS
TROPICAL
P LTE009PSA



PEACH
PESCA
P LTE003PSA



LEMON
LIMONE
P LTE002PSA



TANGERINE
MANDARINO
P LTE005PSA



GREEN
TÈ VERDE
P LTE004PSA



ICED TEA
TÈ FREDDO
P LTE001PSA



BERGAMOT
BERGAMOTTO
P LTE006PSA

Creamy

Decora le tue creazioni,
con gusto!

Bottiglie 750 ml 6 bottiglie/scatola

I prodotti della linea Creamy ODK sono la **perfetta guarnizione** per cocktail, caffè e dessert.

6 gusti, racchiusi in una bottiglia dal design iconico, per un **sapore intenso** e una **consistenza densa e cremosa**: creare opere d'arte sulle bevande non è mai stato così facile come con la linea di Creamy ODK!

La bottiglia "squeezeable" top down, consente di dosare la quantità perfetta per decorare caffè, latte, cocktail e dessert con splendidi motivi: l'unico limite, è la vostra creatività!

Tutti i prodotti della linea Creamy ODK sono inoltre **gluten-free**, affinché nessuno debba rinunciare a gusto e fantasia!



VANILLA
VANIGLIA
LCR002PSA

COCOA
CACAO
LCR001PSA

WHITE CHOCOLATE
CIOCCOLATO BIANCO
LCR006PSA

HAZELNUT
NOCCIOLA
LCR005PSA

PISTACHIO
PISTACCHIO
LCR003PSA

CARAMEL
CARAMELLO
LCR004PSA





ODK Premium Sour

Assapora l'essenza
dei premium sour

Bottiglie 750 ml

6 bottiglie/scatola

Una delle linee più iconiche del brand: i Sour ODK contengono solo ingredienti naturali e sono sviluppati utilizzando solo lime e limoni della migliore qualità, garantendo così un gusto **intenso** ed **autentico**.

I prodotti di punta della linea sono Lime e Lemon Juice **100% NFC**: unici nel loro genere, perché contengono solo lime e limone appena spremuti, non da concentrato, per un gusto potente ed autentico.

Niente viene tolto e niente viene aggiunto: Lime e Lemon 100% NFC risultano essere quindi la soluzione ideale per avere **succo di frutta fresco tutto l'anno**, senza stagionalità!



LIME
100%
LSO006PSA



LEMON
100%
LSO005PSA



SWEET & SOUR
LSO003PSA



CORDIAL
LIME
LCO001PSA



BITTER
CORDIAL
LCO002PSA

Hot Chocolate

Ciocolatte prelibate,
per tutti i gusti

Latta da 1 kg

6 latte/scatola

4 varianti per tutti i gusti, dal sapore deliziosamente intenso della Rich'n Thick a quello con maggiore contenuto di cacao magro della Double Dark, 100% gluten-free.

La nostra ricetta è sviluppata utilizzando **solo cacao accuratamente selezionato**, proveniente dall'Africa e dall'America Centrale, per ottenere il **gusto** più **autentico** possibile.

I prodotti della linea Hot Chocolate ODK sono veloci e pratici da usare, basta aggiungere il vostro latte preferito e miscelare per ottenere una cioccolata ricca di gusto: indispensabili per le fredde giornate invernali!

Perfette anche in **combinazione** agli **sciroppi** ODK, per una **bevanda** ancora **più gustosa**.



DOUBLE DARK DELUXE
LCH001LSA



SILKY SMOOTH
LCH003LSA



RICH'N THICK
LCH002LSA



PURE WHITE
LCH004LSA





ODK Frappé

Una gamma sorprendente di frappé,
gustosi e facili da preparare

La gamma di frappé ODK si è arricchita con **gusti nuovi e sorprendenti!**

In polvere, **100% gluten-free** e facili da preparare, i frappé di questa linea sono assolutamente da provare anche come base a cui abbinare gli altri prodotti della famiglia ODK, dagli Sciroppi ai Fruity Mix, per una bevanda ancora più golosa.

Latta da 1 kg

6 latte/scatola

12 gusti, tutti da provare!



Chai Tea



Il gusto autentico
del Chai Tea... in polvere!

Il Chai Tea ODK regala suggestioni d'oriente in tazza, semplicemente aggiungendo latte: **veloce da preparare** e ancora più facile da gustare. Tè nero, cannella, zenzero, chiodi di garofano... un **mix inebriante** tutto da scoprire ed assaporare.

Disponibile in due varianti: alla Vaniglia, con sentori più dolci e aromatici, oppure Spiced, per gli amanti delle note più intense e particolari. Entrambi gluten-free.



Latta da 1 kg

6 latte/scatola

Da provare **anche freddo**,
con ghiaccio.



CHAI TEA
SPICED
LCA001LSA



CHAI TEA
VANILLA
LCA002LSA





CDK Dried Fruit

Fette di frutta secca
100% naturali

Un'interessante selezione di **frutta di alta qualità, essiccata lentamente e a bassa temperatura**, per mantenere intatte tutte le proprietà organolettiche e nutrizionali. Perfetta per la decorazione di drinks o come snack salutare.

100 g

Buste doy-pack



DROPS OF MAGIC



STILLABUNT



MIXOLOGY REVOLUTION
La magia, esiste.

Stillabunt è il termine classico latino usato per descrivere una “piccola goccia d’acqua” oppure una “lacrima”, tanto piccola quanto miracolosa.

Per questo è il nome perfetto per la nostra **mixology revolution**: bastano pochissime gocce di prodotto per infondere alle vostre creazioni un tocco speciale.

Un'alchimia perfetta tra l'irrinunciabile **qualità** delle materie prime e l'immediata **facilità d'uso** dei prodotti.

Magic Velvet

A natural cocktail foamer like no other

Poche semplici gocce di Magic Velvet creano una **spuma pura e vellutata**, senza alterare il gusto del cocktail.

MAGIC VELVET
FOAMER 95ml
LSFO01GSA



Una soluzione moderna e più sicura

• Nessun rischio di salmonella • Prodotto con estratti naturali • Nessun retrogusto • Vegano • Alcohol free • Gluten free



Botticino 95 ml

6 botticini/scatola

Pratico e conveniente

- Usare il bianco d'uovo è il 300% più costoso rispetto all'utilizzo di Magic Velvet
- Shelf-life notevolmente più lunga rispetto alle uova
- Più semplice e veloce da utilizzare rispetto all'albume
- La spuma dura fino a 3 ore: l'ideale per preparare cocktail con anticipo
- Oltre 600 drink con un solo flacone di Magic Velvet



Bitters

I bitters sono delle miscele aromatiche concentrate per creare cocktail con un gusto raffinato, intenso e sorprendente

La loro origine risale al XVI secolo, quando si assiste ad un'enorme diffusione di questi "elisir" in ambito farmaceutico.

L'utilizzo dei **bitters** come lo intendiamo noi oggi, inizia invece durante la seconda metà del XIX secolo in America, durante l'epoca definita **"Golden Age"**, quando iniziano ad essere impiegati nella miscelazione.

Come suggerisce il nome, i bitters **conferiscono una nota amaricante** che serve ad aggiungere complessità e **profondità** ai **cocktails** e ad **accentuare l'armonia** o il **contrasto** con gli altri sapori presenti nella miscela. L'aggiunta di questa sensazione ad un profilo gustativo che si basa su altri **sapori primari**, ne approfondisce infatti il **carattere**, creando un'esperienza di **consumo** infinitamente più **interessante**.

Botticino 95 ml 6 botticini/scatola

Il nostro laboratorio di Ricerca e Sviluppo testa costantemente nuovi gusti e combinazioni insolite per arricchire la gamma di bitters.



Alcohol Free



Vegan



Concentrated



VIGINTI UNUS XXI
LSB001GSA

UNDE VIGINTI XIX
LSB002GSA

COFFEE
LSB003GSA

CHOCOLATE
LSB004GSA

BURLESQUE
LSB007GSA

OAK SMOKE
LSB01GSA



TONKA BEAN
LSB012GSA

LAVENDER
LSB008GSA

LICORICE
LSB010GSA

TIKI
LSB006GSA

YUZU
LSB005GSA

DOC FIRE
LSB009GSA



VIOLET
LSB014GSA

HONEY
LSB016GSA

GINGER
LSB015GSA

ORANGE
LSB013GSA



ODK
ORSADRINKS.COM

ITALIAN BEVERAGE SUPPLY COMPANY

• *Equipment* •

WORKSTATION LINE



FULL WORKSTATION

AWS004ASA

CARATTERISTICHE

- Coibentazione con poliuretano espanso
- Lavandino con sifone a doccia estraibile
- Risciacqua bicchieri incorporato
- 2 vasche per ghiaccio 48x50 cm (30 lt ca.)
- 5 vaschette frutta 1/9 gn. da 0,2 kg cad. (con tappo ermetico)
- 3 vaschette frutta 1/6 gn. da 1 kg cad. (con tappo ermetico)
- Vano per 6 Speed Bottle (contenitori succhi)
- Vano per 6 cordials/vino
- 2 Speed Rack estraibili (portabottiglie) da 11/12 bottiglie cad.
- Piano estraibile porta Blender e Mixer con foro per cavo

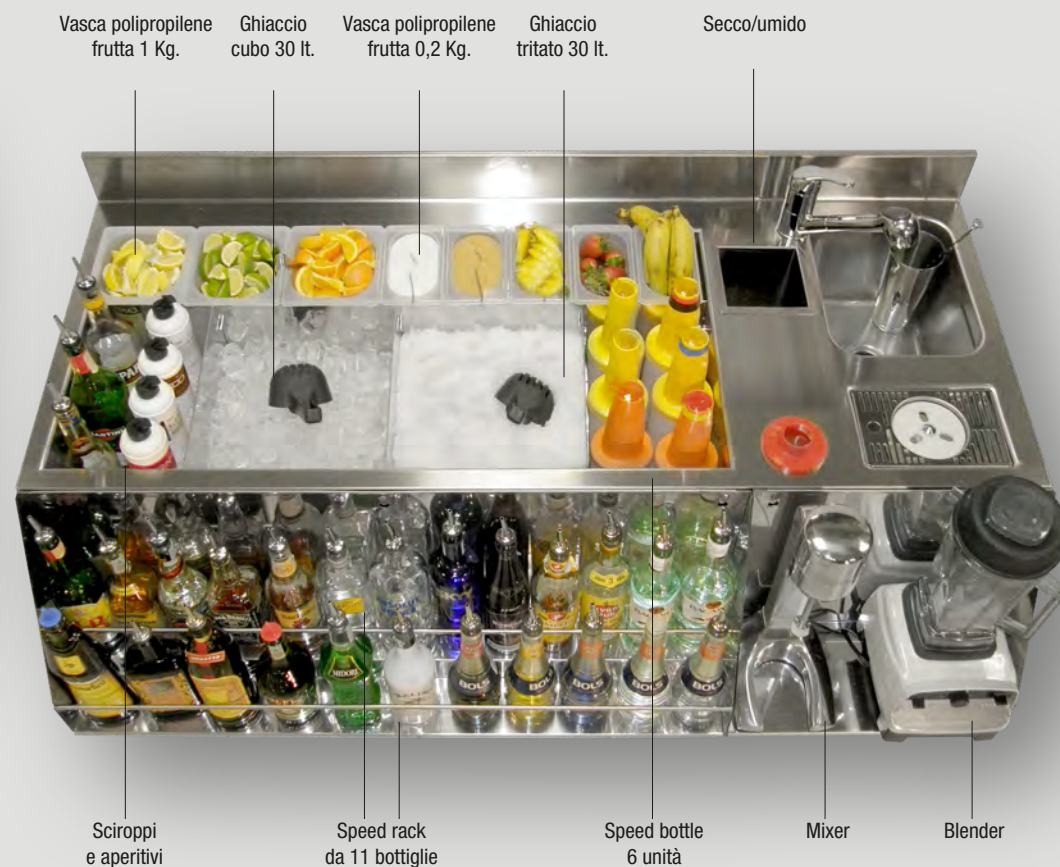

ROMAN CLASSIC - LIGHT

* 15 GIORNI



L/P/A = 70/70/110 cm

DIMENSIONI
L/P/A = 120/70/110 cm

L/P/A = 70/70/110 cm

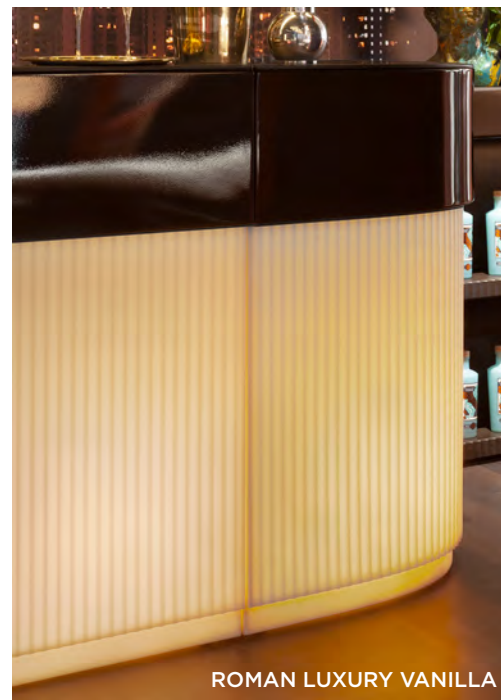

ROMAN LUXURY VANILLA



ROMAN LUXURY



ROMAN CLASSIC



ROMAN LUXURY

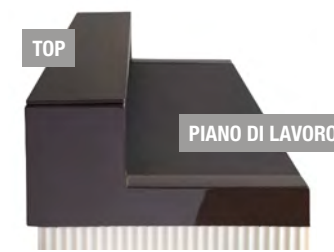

TOP

PIANO DI LAVORO

PIANO DI LAVORO E TOP

TRAMA BIANCO

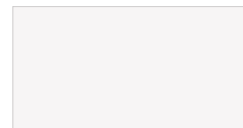

TRAMA MARMO

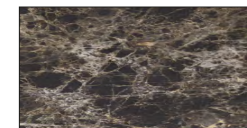

TRAMA WENGE

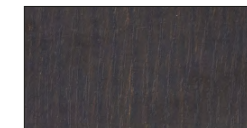

LIGHT BAR



LIGHT BAR
AWS005PSK

LIGHT BAR SENZA VASCA
AWS005PSP



ANGOLARI

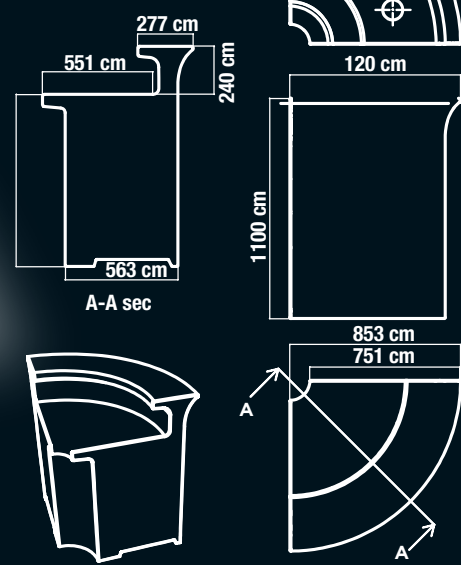

SPEED RACK ABS
84 x 20,5 x 10 cm
AWS002PSA



ANGOLARE
AWS005PSC



ASTROBOARD TOOLS TROLLEY BAR

AWS003ASA

IDEALE PER PICCOLI CATERING

Su richiesta si personalizza il pannello frontale in pvc



150 cm



Le vasche interne di serie sono in polipropilene

STATION ABS

AWS001PSA

MISURE ESTERNE cm 84x54,5x37

MATERIALE Lastre di Mix ABS, Policarbonato e Metacrilato

COLORE Nero

ACCESSORI INCLUSI

- N. 2 divisori bassi (zona succhi e/o pre mix)
- N. 1 divisorio alto (zona ghiaccio)
- N. 1 kit di scarico completo di sifone
- N. 7 vaschette da 1/9 h 100 nere con tappo



SPEED RACK ABS

84x20,5x10 cm
AWS002PSA



SPEED RACK
56x15,5x10 cm
AWS002ASA



EQUIPMENT LINE



**FLAIR
MUDDLER**
Lunghezza 30 cm
ABE014PSC

**CLASSIC
MUDDLER**
In polipropilene
e policarbonato
ABE013PSB



**JIGGER
20/40 ml
ABE026ASS**



**JIGGER
25/50 ml
AMX003ASS**



**POURFECT
EASY**
ABE025PSS



STRAINER
ABE017ASS



**GLASS
Tritan**
AGL003PSS



SHOT GLASS
Policarbonato
AGL001PCC



**FINE M.
Strainer**
AMX002ASS



**THROWING
Strainer**
ABE017ASB

**BOSTON SHAKER
28 oz
ABE001ASS**



**SPEED CUP
20 oz
ABE002ASS**



**MIXING GLASS
ABE004GSS**



**CANNUCCE BIO
LEGNO LIQUIDO**
500 pz - cm 17
compostabili
ABE029SSD



GIANT TWEEZERS
30 cm
AMX013SSA



SPEED OPENER
Acciaio
ABE005ASS



SPEED RACK ABS
84x20,5x10 cm
AWS002PSA



SPEED RACK
56x15,5x10 cm
AWS002ASA



METAL POUR
Conf. 10 pz.
ABE007ASI



POUR CUP RUBBER
Conf. 12 pz.
ABE008PSS



BAR SPOON
ABE015ASR

ABE015ASS

AMX007ASC

ICE SCOOP
ABE009PSS



**PINZE
DA GHIACCIO**
ABE024ASS

INTERLOCKING
Modulare a incastro
33x33 cm
ABE023PSS

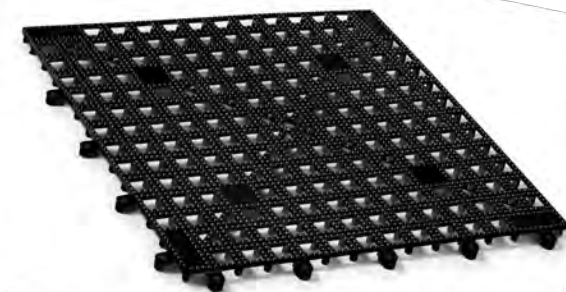

SERVICE MAT
45x30 cm
ABE021GSS

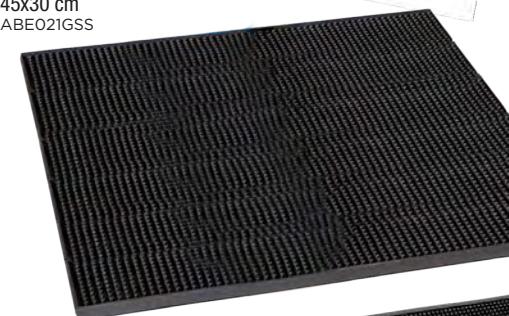

**LIME
SQUEEZER**
ABE010ASS



BAR MAT
70x10 cm
ABE020GSS



CASE LINE



MEDIUM CASE

ACA002BSF

- 3 METAL POUR
- 1 BAR SPOON
- 1 BOSTON SHAKER
- 1 STRAINER
- 1 JIGGER
- 1 SPEED OPENER
- 1 MUDDLER
- 1 CHOPPING BOARD
- 1 KNIFE
- 1 MIXINGGLASS
- 1 LIME SQUEEZER



PROFESSIONAL CASE

ACA003BSF

- 3 METAL POUR
- 1 BOSTON SHAKER
- 1 STRAINER
- 1 JIGGER
- 1 SPEED OPENER
- 1 MUDDLER
- 1 CHOPPING BOARD
- 1 ICE TONG
- 1 LIME SQUEEZER
- 1 NUT GRATTER
- 1 FINE STRAINER
- 1 BARSPOON
- 1 KNIFE
- 1 ZESTER
- 1 DOUBLE PEELER
- 1 CORKSCREW
- 1 SPEED CUP
- 1 MIXING GLASS
- 1 SERVING CLOTH



FLAIR TROLLEY

ACA004BSF

- 1 MUDDLER FLAIR XL
 - 1 JIGGER
 - 1 BAR SPOON
 - 1 ICE TONG
 - 1 ICE SCOOP
 - 1 STRAINER
 - 1 SPEED OPENER
 - 1 LIME SQUEEZER
 - 1 CHOPPING BOARD
 - 1 KNIFE
 - 8 METAL POUR
 - 8 PLASTIC POUR
 - 4 BOSTON SHAKER
 - 1 SPEED CUP MIXING GLASS
 - 4 FLAIR BOTTLES CLEAR*
 - 4 FLAIR BOTTLES WHITE*
- * può essere venduto senza bottiglie flair



TROLLEY

SENZA BOTTIGLIE FLAIR

ACA004BSM

TROLLEY VUOTA

ACA004BSE



SMALL CASE

ACA001BSF

- 3 METAL POUR
- 1 BAR SPOON
- 1 BOSTON SHAKER
- 1 STRAINER
- 1 JIGGER
- 1 SPEED OPENER
- 1 MUDDLER
- 1 LIME SQUEEZER
- 1 MIXING GLASS



PORTABLE 3D PRINTER

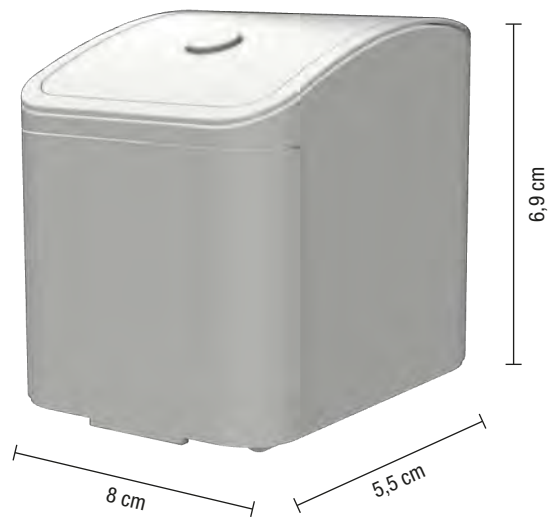

STAMPANTE 3D PORTATILE

Stampante portatile per personalizzare con loghi o immagini la schiuma di caffè, cappuccino, birra, drink... e molto altro.

Dimensioni di stampa: da 2,5 a 9 cm

Stampa con inchiostro alimentare commestibile

PORTABLE 3D PRINTER

Portable printer to personalize with beautiful images your cappuccino, beer, cocktail foam...and much more.

Print size: from 2,5 to 9 cm

Print with edible food ink



ORSA DRINKS srl

Via Marconi, 115 • 12030 Marene CN • Italy
+39 0172 743043 • info@orsadrinks.com

www.orsadrinks.com